

See discussions, stats, and author profiles for this publication at: <https://www.researchgate.net/publication/324011149>

# THE BIOMASS AS AN ENERGY SOURCE AND ITS APPLICATION BENEFITS

Article · February 2018

CITATIONS  
4

READS  
4,459

4 authors:



**Michail Papoutsidakis**  
University of West Attica

176 PUBLICATIONS 447 CITATIONS

SEE PROFILE



**Eleni Symeonaki**  
University of West Attica

43 PUBLICATIONS 169 CITATIONS

SEE PROFILE



**Dimitris Tseles**  
University of West Attica ( former Piraeus University of Applied Sciences - Technol...

294 PUBLICATIONS 663 CITATIONS

SEE PROFILE



**Christos Drosos**  
University of West Attika

42 PUBLICATIONS 90 CITATIONS

SEE PROFILE

Some of the authors of this publication are also working on these related projects:



Industrial Automation and Data Acquisition And Control [View project](#)



Technorecycle [View project](#)



# THE BIOMASS AS AN ENERGY SOURCE AND ITS APPLICATION BENEFITS

M. Papoutsidakis  
Dept. of Automation  
Engineering,  
Piraeus University of  
Applied Sciences,  
Athens, Greece

C. Drosos  
Dept. of Automation  
Engineering,  
Piraeus University of  
Applied Sciences,  
Athens, Greece

E. Symeonaki  
Dept. of Automation  
Engineering,  
Piraeus University of  
Applied Sciences,  
Athens, Greece

D. Tseles  
Dept. of Automation  
Engineering,  
Piraeus University of  
Applied Sciences,  
Athens, Greece

**ABSTRACT** - This paper aims to present and analyze the need for greater use of renewable energy sources, in particular biomass, in order to meet the need to produce energy for humans and their daily needs in a manner friendly to the environment.

In the first chapter, are presented the energy production are used extensively worldwide to meet human needs, the negative consequences for the environment, and the use worldwide of renewable energy sources.

Thereafter, the power sources are analyzed by feedstock biomass conversions may be made to cover most needs, as the advantages and disadvantages of its implementation.

Then, analyze the way that we can exploit biomass as a transport fuel and fuel types derived from it, and the economic benefits from production or import.

Finally, listed examples of energy utilization of biomass have been implemented such as district heating residential areas, the electricity and heat cogeneration plants for the operation and exploitation of municipal waste.

## I. INTRODUCTION

Renewable energy sources began to grow more strongly in the early seventies due to the oil crisis that hit the energy market at that time. The figure below shows the annual growth rate of renewable energy sources between 1990 and 2013.

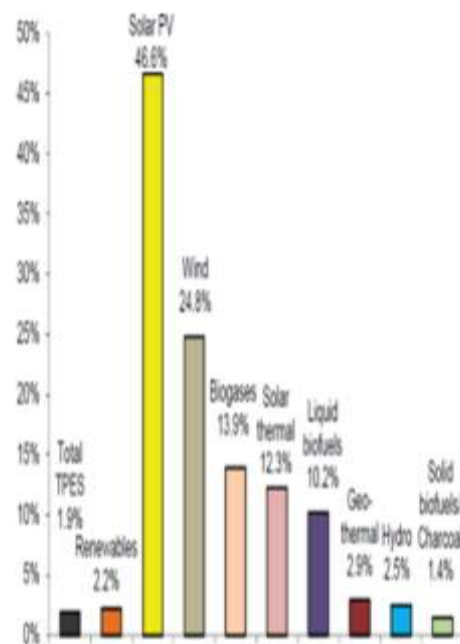

Figure 1

The research and development of solar energy applications is becoming more prominent in relation to the rest of the renewable energy sources while wind and biomass are at relatively lower levels.

In general, global primary energy production of renewable sources occupy a small percentage of the market (13,5%) while oil, natural gas and coal continue to be the main means occupying 80.4% of production.

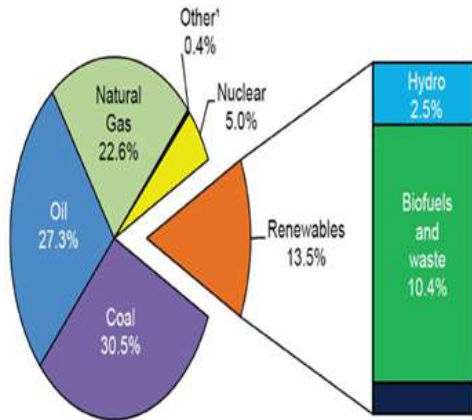

Figure 2

Nevertheless, regarding the contribution of the renewable energy sources in global electricity production, we can see in the figure below that the RES with 21.7% are located just behind coal (41%) and have almost the same share of natural gas (21.8%).

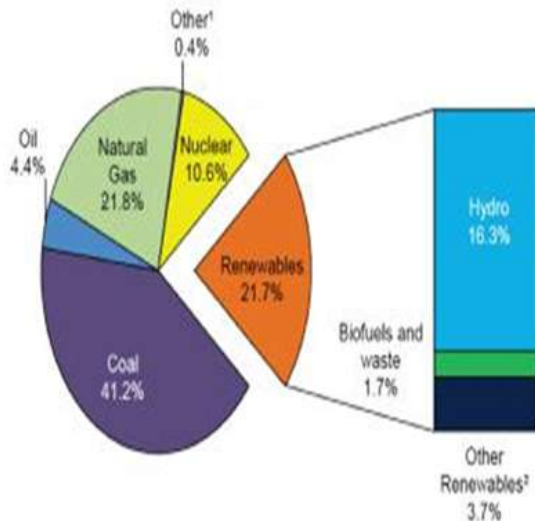

Figure 3

Finally, it is very important to mention that biomass for 2013 is the dominant source of energy in relation to the rest of RES as it accounts the 73% of all renewable sources, with the overwhelming majority being covered by solid biomass and charcoal.

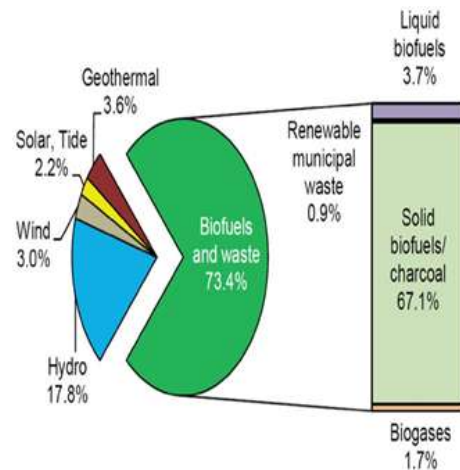

Figure 4

Greece is trying for the contribution of the development of renewable energy sources to face climate change and saving natural resources, following the recommendation of the European Union, sets the target, by 2020, RES to constitute 18% of the domestic energy production. The graph below shows the evolution of RES contribution to final energy consumption in the countries of the EU and Greece for the period 2004-2013. There is a continuing development of RES, which results in 2013 Greece is at the levels that the European Union has set itself.

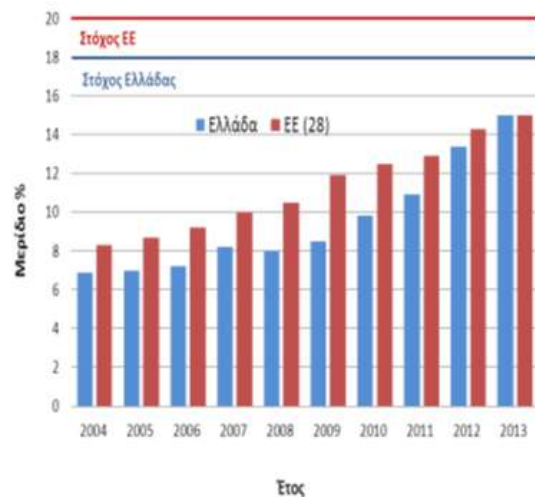

Figure 5

In 2012, electricity production in Greece comes mainly from thermal power stations. Lignite is the major domestic energy source, the natural gas follows, while RES is far behind. In 2013 electricity production from lignite and natural gas drops significantly in contrast to hydroelectric power and RES, which shows that our country is moving in the right direction.

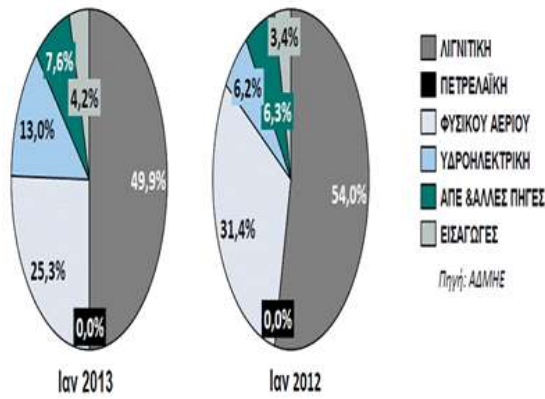

Figure 6

The term biomass means all carbon-containing materials (solids, liquids or gases) that can be converted into energy (bio-energy). These materials can be burned directly to produce heat, power or converted to biofuels (charcoal, biodiesel etc.).

Biomass can come either directly from a primary source, such as plants for example, or indirectly from urban, industrial or rural waste.

Urban waste is classified as residual biomass, derived from human activities, also includes the organic fraction of urban solid waste and urban waste water is separated into household waste and sewage directly from households. Also, wood residues from processes such as cutting, barking of plants. Wood producing by-products such as branches, pellets, sawdust and also waste from certain organic processing industries (mainly papermaking) with subpopulations ionic liquid paper-black liquor and fuel skin.

Agricultural residues also belong to the residual forms of biomass. Their main feature is their high energy density where it is combined with their smallest volume, they have a much lower cost, making them more energy-efficient. They include agricultural crop residues and processing of agricultural products.

Finally, another major source of bioenergy is energy crops. These can be considered as traditional crops where the final product is used for energy production and biofuels, as well as new crops with high productivity in biomass per unit of land.

## II. METHODOLOGY

Biomass process technologies are divided into two main categories. The first category is the direct combustion of raw biomass or combustion after some natural treatment. In the second category biomass is transformed into useful products by the utilization of microorganisms and enzymes through industrial methods.

The most widespread and commonly used method is the incineration of raw biomass and belongs to thermo-chemical methods. Wood is burned in two stages as it contains two fuels, the volatile matter and char. More specifically, the simplest form of treatment for the production of charcoal is called conventional pyrolysis which, almost in the absence of air, involves heating the wood to a specific temperature range (300-500°C) until the volatile material of the wood is completely removed. But the main disadvantage of this method is that it is not particularly efficient because of the need of a number of sophisticated technologies for collecting and utilizing it.

Another method is gasification where a series of chemical processes are carried out in which the solid fuel reacts with steam and air or oxygen for the purpose of producing gaseous fuels used in internal combustion engines or boilers. The process comprises heating the biomass at temperatures of greater than 300°C and up to 1000°C and pressure from 1 atm up to 30 atm to produce a combustion gas with low or intermediate calorific value and the carbonate. Although the use of oxygen increases the performance of the process, its cost is increasing too.

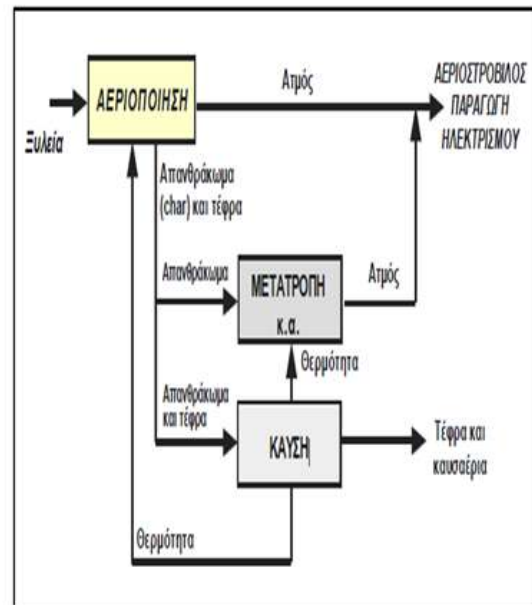

Figure 7

A very useful method of gasification is flash cracking which can be used to produce liquid fuels and succeeds when the biomass is rapidly expelled at high temperatures (800-900°C) with tightly controlled air quantities. The product produced is a mixture of solid, humid and condensable gases rich in carbon monoxide and hydrogen. This technology is one of the most promising solutions as the produced bio-oil can be used as a substitute for oil and can be also used in the production of electricity.





Finally, with catalytic cracking, an increase of performance in some products is achieved by the use of special catalysts. The produced liquid products can be used not only in the production of electricity but also in heating.

There are also biochemical methods where biofuels are produced by fermentation. The fermentation product contains 10% ethanol, which is obtained by distillation. This process requires large amounts of energy. Despite the fact that the cost of bioethanol is higher than the cost of gasoline, its use as fuel is rising more and more. This is because bioethanol is cleaner from an environmental point of view, but it also gives an outlet to agricultural problems.

Also, another biochemical method is anaerobic fermentation in which the decomposition of the organic material is achieved by the absence of oxygen and a mixture of methane and other gases is produced. This is a natural process that takes place at the bottom of the lakes because of the prevailing conditions. Biogas production has also been developed from livestock manure and landfill waste (landfill gas).

Landfill gas can be burned directly for heat or electricity generation and, more rarely, if it is too pure, can be added to the natural gas network.

The exploitation of biomass can be achieved in a variety of ways. One way is burning the landfill. This is a special case of combustion where it is similar to the simple combustion process but it is necessary to perform special treatment before and after, due to the change of fuel composition, its variation in morphology and the increased pollutants produced. The heat generated in waste incineration plants is useful for the production of biogas where, by appropriate processes, it is used for the production of electricity. In this way, the volume and the weight of the rubbish are reduced. Although in the specific application only the combustion of the organic fraction of the waste produces green electricity, there will be an increase in its production due to the fact that in the upcoming years the landfill will be banned.

Another way of utilizing biomass is co-generation of electricity and thermal energy. Conventional ways of generating electricity reject large amounts of heat into the environment in the form of flue gas. With combined heat and power generation from the same source, most of the heat is recovered and used. This also helps to save energy and reduce pollutant emissions. It also reduces electricity transmission losses, as cogeneration systems are usually decentralized and closer to consumers in relation to central power plants. Consumers of heat produced by these plants can be residents of villages or even towns, which will be heated by some district installation, greenhouses or industrial units with increased heat demand. Also, the

energy produced can be used for self-supply or sold to the electricity suppliers of each country.

Another method for utilizing biomass is district heating. It provides hot water, both for heating and direct use in a whole building, village or city, from a central heating station. The heat generated is transported by pipelines that start from the station and reach up to the heated buildings. Non-conventional fuels are used with district heating and a high degree of efficiency is achieved, resulting in significant economic benefits and reduced environmental pollution. District heating is usually used by countries with a relatively cold climate, with large amounts of wood and where alternative fuels are scarce. The following picture shows the construction of a district heating network in Greece.



**Figure 8**

### III. CONCLUSIONS

From all the above, we come in conclusion that the constantly increasing needs of people combined with the increase of the world's population are producing more and more waste that we can use to secure our energy needs. The interest in second-generation biomass and its processing methods such as aeration, fermentation etc. enables us to exploit the fuels produced either in liquid or in solid form. Also, the first applications of third and fourth generation biofuels, such as algal production, show the first positive results. Derivatives of



biomass are in a position to replace or absorb a share of energy production while continuing to invest in the research and development of biomass we will be able to contribute effectively to the problems posed by climate change due to pollution caused by the exploitation of non-renewable sources. It will also help reduce the depletion of oil reserves and will help to make more people use the good of energy. By taking advantage of biomass, we are given the opportunity to harness the waste we create in an environmentally friendly way and to cope with the oil crisis we are experiencing over the past few years.

#### IV. ACKNOWLEDGMENTS

All authors would like to express their gratitude to the Post-Graduate Program of Studies “Automation of Productions and services” of PUAS, for the financial support to undertake this research project

#### V. REFERENCES

- [1] Renewable Energy Sources & Environment, CRES, Athens 1997.
- [2] <http://www.cres.gr/kape/index.htm>
- [3] <https://el.wikipedia.org/>
- [4][http://kpekastor.kas.sch.gr/energy1/human\\_activities/forms\\_of\\_energy.htm](http://kpekastor.kas.sch.gr/energy1/human_activities/forms_of_energy.htm)
- [5][http://egpaid.blogspot.com/2009/09/blog-post\\_9863.html](http://egpaid.blogspot.com/2009/09/blog-post_9863.html)
- [6][http://library.tee.gr/digital/kdth/kdth\\_3460/kdth\\_3460\\_contents.htm](http://library.tee.gr/digital/kdth/kdth_3460/kdth_3460_contents.htm)
- [7] [http://www.cres.gr/kape/CRES\\_annual\\_report\\_2009.pdf](http://www.cres.gr/kape/CRES_annual_report_2009.pdf)
- [8] <http://ec.europa.eu/energy/en/topics/renewable-energy>